

ZL-HV60AR Series Fan Coil Controller

1. Introduction

- ZL-HV60AR make use of super robust MCU, and excellent components, with simple and easy interactivity. With 86*86mm dimension which is same size as standard electrical switch box, it is convenient in application.
 - The controller suits for zones temperature control of central air conditioning.
 - ZL-HV60AR has communication RS485 function, it can control temperature controller in long distance.
-

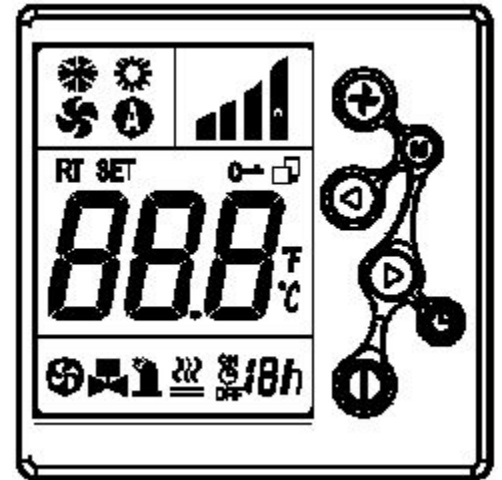

2. Specification

- Sensor: NTC
 - Control accuracy: $\pm 1^{\circ}\text{C}$
 - Celsius temperature set range: $5\sim 35^{\circ}\text{C}$
 - Celsius temperature display range: $-9\sim 50^{\circ}\text{C}$
 - Working environments: $0\sim 45^{\circ}\text{C}$
 - Humidity: $5\sim 95\%$ RH(without dew)
 - Button: Touch-button
 - Power consumption: $< 2\text{W}$
 - Power supply: AC $85\sim 260\text{V}$, 50/60HZ
 - Load limitation: 2A with resistant load; 1A with inductive load
 - Terminals: 2 lines X 1.5 mm^2 , or 1 line x 2.5mm^2
 - Shell: fire-proof ABS
 - Dimension: $86\text{x}86\text{x}12\text{ mm}$
 - Installation: 60mm standard
 - Protection: IP30
-

3. Hardware Introduction

- 3.1 The system has six buttons, ON/OFF ①、Clock Set ②、Mode ③、Fan speed ④、Temp+ ⑤、Temp- ⑥.
- 3.2 The system has four ways of relay output, one way control electric valve, three ways control fan.
- 3.3 Fan work mode
 - 3.4.1 Fan speed: High, Medium and Low, control by three ways of relay output;
 - 3.4.2 There are two fan working mode, set F1 to select the mode;
 - 3.4.3 F1=1, valve off, fan stops;
 - 3.4.4 F1=2, valve off, fan keeps working;
 - 3.4.5 Factory default F1=1;

4. Set parameter

4.1 The parameters of the controller are divided into user parameters and system parameters. In the parameter set status, if room temperature display area shows “t1”, then we could enter into user menu, shows “t2”, then we could enter into system menu. In any status, we are able to set parameters.

4.2 Hold “▷” and “◁” key for three seconds, the system will enter into parameter set status, and room temperature display area will show “t1”. Pressing “▷” or “◁” key switches selection menu “t1” or “t2”

4.3 Set user parameters

4.3.1 When the room temperature display area shows “t1”, press “M” key, enter into user parameter set status. At this time room temperature display area shows user parameter sign “U1”. Set temperature display area shows corresponding parameter data.

4.3.2 Press “M” key to switch selection user parameter, At this time the set temperature display area will show its corresponding parameter data.

4.3.3 Press “▷” or “◁” key to modify the corresponding parameter data.

4.3.4 When set completes, keep depressing “M” key for three seconds to exit parameter set status, The set data are saved. The controller will working according to new set parameter data 3 seconds later.

4.3.5 In the set parameter status, do not press any key for 30 seconds, the mode exits, and the set parameter are not saved.

4.3.6 User Parameter Table:

Parameter code	Function	Setting range	Explain	Factory Setting
U1	Low temperature protection	0~1	0: off 1: on	0
U2	Restart	0~1	0: off 1: on	0
U3	Keypad Lock	0~1	0: off 1: on	0

4.4 Set system parameter

4.4.1 The controller must use the password to enter the system parameter setting status

4.4.2 When the room temperature display area shows “t2”, press “M” key, enter into set system parameter status, At this time room temperature display area show password sign “--”, “--” represent two digital password. use “▷” or “◁” key enter password, again press “M” key confirm. If correct, shows system parameter sign, at this time set temperature display area shows corresponding parameter content, else exits.

4.4.3 Press “M” key to switch system parameter. At this time, the set temperature display area will show its corresponding parameter data.

4.4.4 Press “▷” or “◁” key to modify the corresponding parameter data.



4.4.5 When set completes, keep depressing “M” key for three seconds to exit parameter set status, The set data are saved. The controller will working according to new set parameter data 3 seconds later.



4.4.6 In the set parameter status, do not press any key for 30 seconds, the mode exits, and the set parameter are not saved.

4.4.7 System Parameter Table:

Parameter Code	Function	Setting range	Instruction	Factory Setting
F1	Fan mode	1~2	1: Temperature reaches set data, fan stop 2: Temperature reaches set data, fan work	1
F2	Temperature Sensor Calibration	-9~+9°C		0
F3	Passwords	0~99		11
F4	Baud rate	1~4	1:2400 2:4800 3:9600 4:19200	3
F5	ID	1~99	485 ID	1





5. Operation instruction

5.1 On/Off: Keep depressing“”key for two seconds, is on; keep depressing“”key for two seconds again, off.

5.2 Temperature Set: Press  and  to set the temperature

5.3 Mode Selection: Press  , display “”means cooling, “”heating, “”ventilation

5.4 Fan Speed Selection: Press“” to select high, medium, low and auto fan speed

5.4 When off, keep pressing “Timing setting  ” for 2 seconds, enter power-on timing setting mode. “ON” blinking, press “” or “” to adjust the time, time setting range: 0~16 hours, when it is “0”, means cancel the function. Keep pressing “Timing setting  ” for 2 seconds, enter power-on timing mode. No pressing after 30 seconds, it will quit the set. Or press “ON/OFF button” exit setting mode.



6. Function Instruction



6.1 Low temperature protection: In standby status, when the room temperature $\leq 5^{\circ}\text{C}$,the controller will be on automatically to heat mode, LCD shows“”, the fan runs in high speed, and the valve is on.When the room temperature $\geq 7^{\circ}\text{C}$, the controller automatically off, and return standby status.



6.2 Temperature Calibration: Temperature calibration range: $-9^{\circ}\text{C}\sim 20^{\circ}\text{C}$, the step is 1°C for every key press. This function can be adjusted through parameter F3, see “System Parameter Table”.



6.3 Restart Function: Status memorized, and automatically come back to previous running status after power supply comes again. This function can be selected through parameter U2, see “User Parameter Table”.

6.4 Keypad Lock: Use this function, LCD shows“”. At this time only control parameter setting, other function was locked. This function can be set through parameter U3, see “User Parameter Table”.

6.5 When electric valve is on,”” is on; When electric valve is off,””is off.

6.6 When the fan is on,””is shine; when the fan is off,””is off.

6.7 This controller has RS485 communication, sign“”is shine when its not in communication. Sign“”is blinking when in communication.

6.8 Restore default parameter values:Under power off status, press“”, the power on, LCD shows “dEF”, at this time to loosen“”, press“” again, “dEF” blink three times, this time the controller parameters has been restored to its default value

6.9 Temperature Sensor Problem Warning : When the temperature sensor failure, controller close all output, room temperature display area shows blinking "E1", Short circuit when the room temperature display area flicker "E2".

7. Warning

- 7.1 Qualified technicians for installation
 - 7.2 Avoid high pressure to LCD
 - 7.3 Avoid water, mud and other sundry into the thermostat
-

8. Wiring Diagram

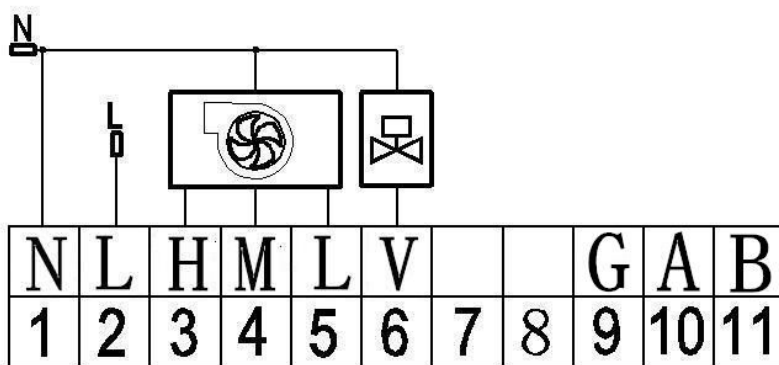

9. Installation

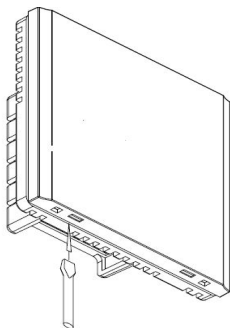

(1)

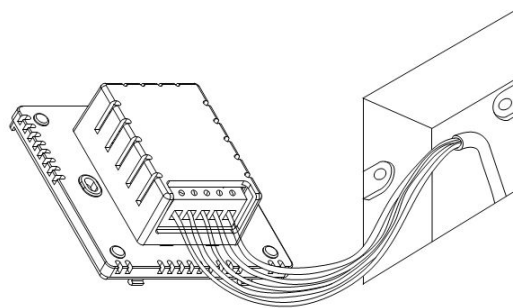

(2)

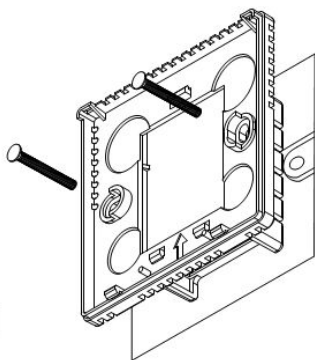

(3)

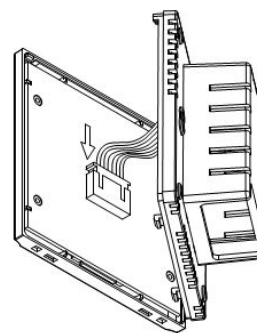

(4)

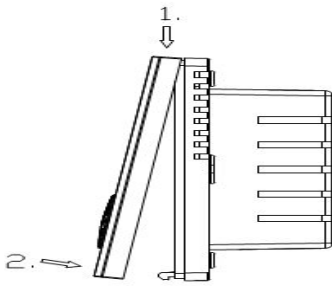

(5)