

ZL-7801C Humidity and Temperature Controller Manual V1.2

Feature

ZL-7801C is an intelligent temperature and humidity controller. IP65 level front panel protection, convenient operation and easy installation. Suitable for control of incubator, climate chamber, greenhouse, warehouse, and so on.







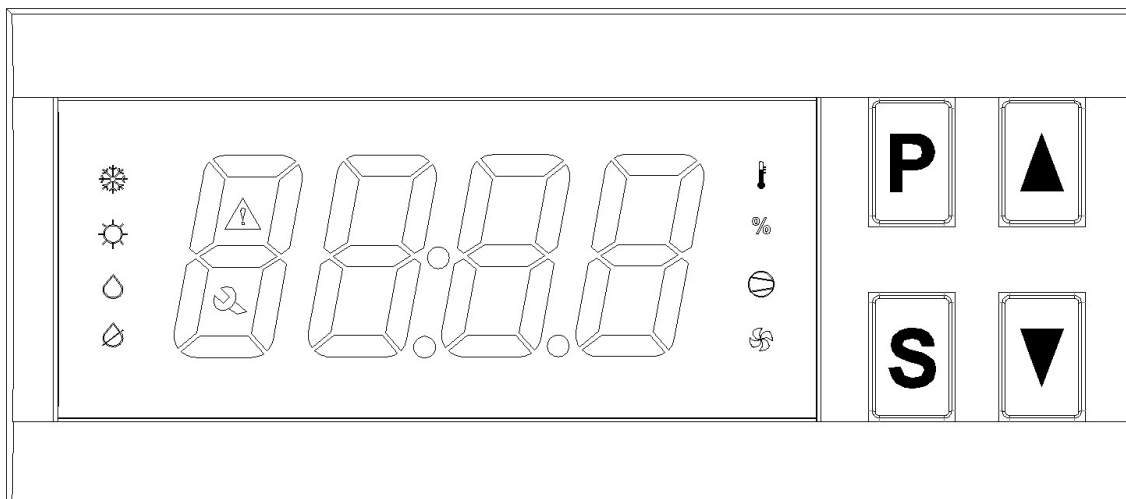



Specification

- ◇ Power supply: 100 ~ 240Vac 50/60Hz
- ◇ Input Signal:
 - One humidity and temperature sensor
 - Wire length 1.5 meter
- ◇ Output load: (All based on resistive load)
 - R1 load, 5A/250Vac
 - R4 and R5 load, 3A/250Vac
 - R2 and R3 load, 16A/250Vac
- ◇ Setting Range:
 - Humidity 0 ~ 100% RH
 - Temperature -20 ~ 120°C
- ◇ Sensor accuracy:
 - Humidity $\pm 5\%$
 - Temperature $\pm 1\%$
- ◇ Working environment:
 - Humidity 10 ~ 90% RH without dew
 - Temperature -20 ~ 45°C
- ◇ Device dimension:
 - W78 * H34.5 * D71 mm
- ◇ Drilling size:
 - W71 * H29 mm
- ◇ Case materials: PC + ABS, fire proof
- ◇ Protection level: IP65 (front panel only)

Display



Eco mode: The brightness of display will reduce when no key operation for 30 seconds.

Icon	Function	On	Off	Blinking
	Temp. load (R3)	Load energized	Load de-energized	The load is delay protecting
	Cool mode	Cool mode		Setting temp. point
	Heat mode	Heat mode		Setting temp. point
	Humidity load (R2)	Load energized	Load de-energized	The load is delay protecting
	Humidify mode	Humidify mode		Setting humidify point
	Dehumidify mode	Dehumidify mode		Setting humidity point
	Repair		No fault	Faulty
	Warning		No Warning	Warning
	Temp. display	For temp.		Temp. setting / warning
	Humidity display	For humidity		Humidity setting / warning
E1	Fault		No fault	Sensor fault
E3	Fault		No fault	Temp. exceeds up limit
E4	Fault		No fault	Temp. exceeds down limit
E5	Fault		No fault	Humidity exceeds up limit
E6	Fault		No fault	Humidity exceeds down limit
UnL	Hint	Restore to factory default settings		

Key Operation

Temperature and humidity setting

Keep [S] depressed for 3 sec. to enter into temperature and humidity setting. Digits show set temperature.

Press [P] to switch between humidity & temp. setting. Press [▲] or [▼] to set the value (Fast set by keeping pressed).

Keep [S] depressed for 3 sec. to exit and saving. The set will also be saved if no key operation for 30 sec., then exit.

System parameters setting

Keep [P] depressed for 3 sec. to enter into parameter setting.

If the password is not 0000, digits shows "--0".

Press [▼] to select the digit of the password, press [▲] to set value (0-9) of the digit.

Press [S] to confirm. If password is correct, show the parameter code.

If the password is 0000, show parameter code.

Press [▲] or [▼] to select the code (see the table below). Press [S] to enter the code setting.

Press [▲] or [▼] to set the value of this code. Press [S] to return.

Keep [P] depressed for 3 sec. to exit and save. The set will also be saved if no key operation for 30 sec., then exit.

Code	Function	Range	Remark	Factory Set
U10	Temp. control mode	H/C	H: Heat mode; C: Cool mode	H
U11	Temp. hysteresis	0.1 ~ 20°C		0.1
U12	Time delay protection for temp. load	0 ~ 30 min		0
U13	Temp. calibration	-9.9 ~ +9.9°C		0
U20	Humidity control mode	H/P	H: Humidify mode; P: Dehumidify mode	H
U21	Humidity hysteresis	0.1 ~ 20%		2
U22	Time delay protection for humidity load	0 ~ 30 min		0
U23	Humidity calibration	-9.9 ~ +9.9%		0
U40	Timer 1, period 1, time unit	0 ~ 2	0: sec; 1: min; 2: hour	1
U41	Timer 1, period 1, time	1 ~ 9999	R5 on, R4 off	60
U42	Timer 1, period 2, time unit	0 ~ 2	0: sec; 1: min; 2: hour	1
U43	Timer 1, period 2, time	1 ~ 9999	R4 on, R5 off	60
U45	Timer 2, period 1, time unit	0 ~ 2	0: sec; 1: min; 2: hour	0
U46	Timer 2, period 1, time	1 ~ 9999	R1 on	30
U47	Timer 2, period 2, time unit	0 ~ 2	0: sec; 1: min; 2: hour	1
U48	Timer 2, period 2, time	1 ~ 9999	R1 off	30
U50	Display content alternating time	1 ~ 30 sec	Only when no warning	5
U60	Timer 2 function mode	1 ~ 2	1: Timer only 2: Timer + limit_protection	2
U61	Temp. up limit (relative value)	0.0 ~ 120.0°C	Absolute point = (Set-point + U61)	0.2
U62	Temp. low limit (relative value)	0.0 ~ 120.0°C	Absolute point = (Set-point - U62)	57.8
U63	Humidity up limit (relative value)	1.0 ~ 100.0%	Absolute point = (Set-point + U63)	5
U64	Humidity low limit (relative value)	1.0 ~ 100.0%	Absolute point = (Set-point - U64)	60
U70	Timer 1, repeat times	0 ~ 9999	0: Timer 1 never stops	0
U99	Password	0000 ~ 9999	0000: skip password	0000

Control Function Instruction

Temperature control

Heat mode (U10 = H)

When $\text{room_temp.} \leq \text{set_temp.} - \text{【temp. hysteresis, U11】}$, and temp. load (R3) has stopped for **【Time delay protection for temp. load, U12】**, temp. load (R3) will be on.

When $\text{room_temp.} \geq \text{set_temp.}$, temp. load (R3) will be off.

Cool mode (U10 = C)

When $\text{room_temp.} \geq \text{set_temp.} + \text{【temp. hysteresis, U11】}$, and temp load (R3) has stopped for **【Time delay protection for temp. load, U12】**, temp. load (R3) will be on.

When $\text{room_temp.} \leq \text{set_temp.}$, temp. load (R3) will be off.

Load delay protection

After powered supplied, temp. load (R3) needs the time of **【Time delay protection for temp. load, U12】** to start.

Humidity control

Humidify control

When $\text{room_humidity} \leq \text{set_humidity} - \text{【humidity hysteresis, U21】}$, and humidity load (R2) has stopped for $\text{【Time delay protection for humidity load, U22】}$, humidity load (R2) will be on.

When $\text{room_humidity} \geq \text{set_humidity}$, humidity load (R2) will be off.

Dehumidify control

When $\text{room_humidity} \geq \text{set_humidity} + \text{【humidity hysteresis, U21】}$, and humidity load (R2) has stopped for $\text{【Time delay protection for humidity load, U22】}$, humidity load (R2) will be on.

When $\text{room_humidity} \leq \text{set_humidity}$, humidity load (R2) will be off.

Load delay protection

After powered supplied, humidity load (R2) needs the time of $\text{【Time delay protection for humidity load, U22】}$ to start.

Timer 1 control (R4, R5)

During period 1, R5 on, R4 off.

During period 2, R4 on, R5 off.

If the repeat times (U70) is set to 0, it will repeat infinitely. Or the timer will stop after the times of full period = U70.

Timer 2 control (R1)

During period 1, R1 on.

During period 2, R1 off.

Temperature and humidity limit protection

U60 = 1, R1 is timer output only.

U60 = 2, R1 is timer output + limit protection output

When temperature or humidity is beyond their limit (U61, U62, U63, U64), R1 will be on.

Sensor

When the sensor is broken, controller shows "E1", humidity and temperature loads will be off.

When the display value is different from real value, it can be calibrated (U13, U23).

Do not plug in, or out the sensor when the power is supplied.

Factory setting:

Keep 【P】 and 【▲】 depressed simultaneously for 5 sec., the device displays "UnL", press 【▼】 twice, the controller will reset all parameters to factory default settings.

Installation Procedure

Insert the controller into hole (step one) Slide the bracket to fix the device (step two)

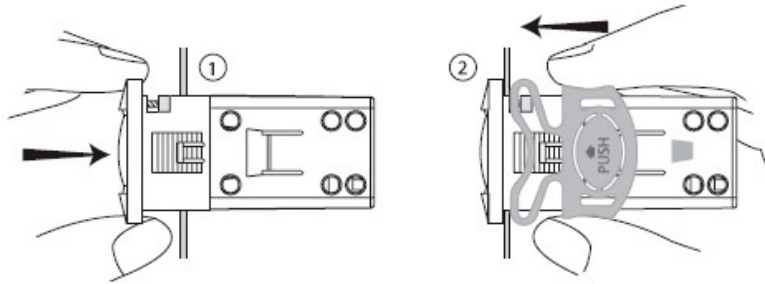

Warning



- Electrical wiring must be manipulated by certified electrician.
- Wrong power supply may damage the device and system seriously.
- Try with effort to layout the sensors and switches line apart from inductive load lines and power supply lines. The sensors and switches lines are not allowed go with the power supply lines and inductive load lines in a same pipeline, and are not allowed to pass near the contactor, breaker and the similar.
- Reduce the length of sensors' wiring if possible. Avoid forming a spiral shape near the power devices.
- Avoid direct contact with the internal electronic components.
- After finishing and checking the electrical wiring, before connecting them to the device, please follow this instruction: Pay attention the "electrical wiring diagram" below, wrong connection possibly damages the device and the system, and may be dangerous to the user. All security and protecting device for the equipment are necessary. They are very important to protect the equipment, and the user's safety.

Electrical Wiring Diagram

